

TRI-Q CANARD PLANFORM

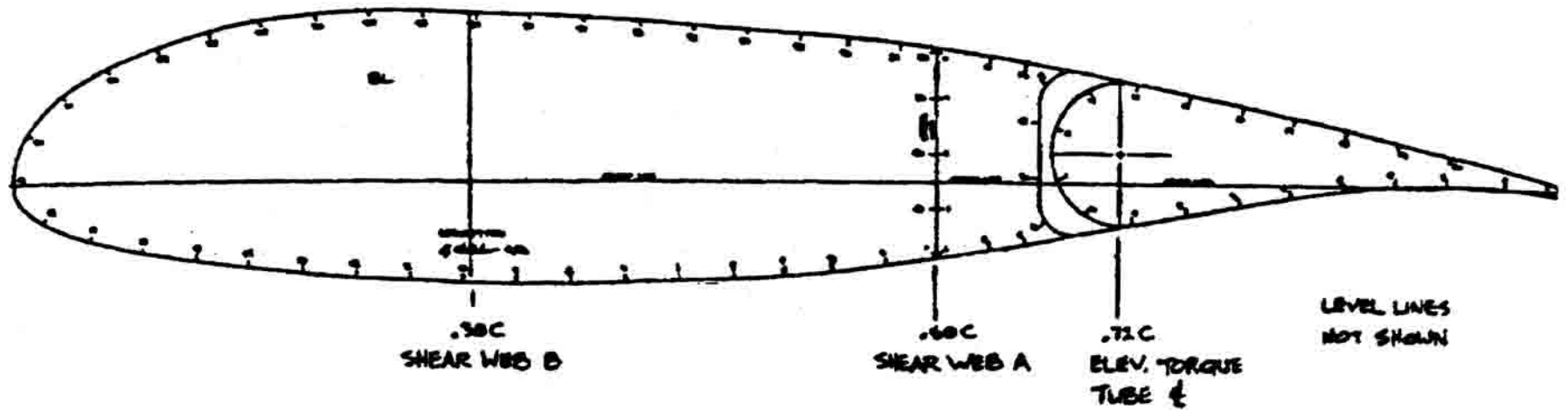

CANARD LS(1)0417Mod AIRFOIL

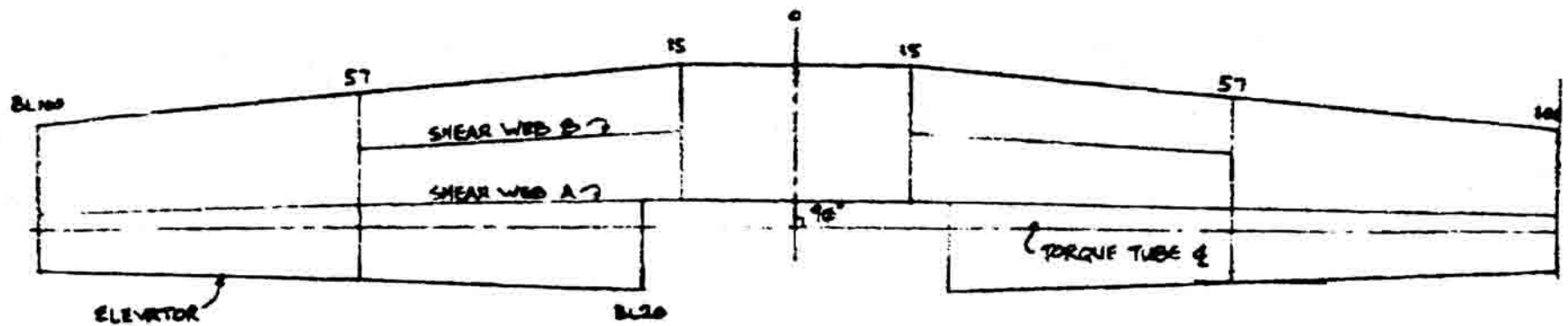

TRI-Q CANARD PLATFORM

SCALE: 1:20

A. K. Killebrew
May '86

200" CANARD TOP LAYUP SCHEDULE

TRI-Q SPARLESS CANARD

TOP SURFACE LAYUP SCHEDULE

200" SPAN, 1100 LBS, 4.4 G

LS(1)0417 MOD AIRFOIL

Raw Cloth Dimensions

M. Waddelow
6/86

G	13" x 190"
H	12" x 130"
I	11" x 100"
J	10" x 80"
K	9" x 60"
L	8" x 50"
M	7" x 40"
N	6" x 32"

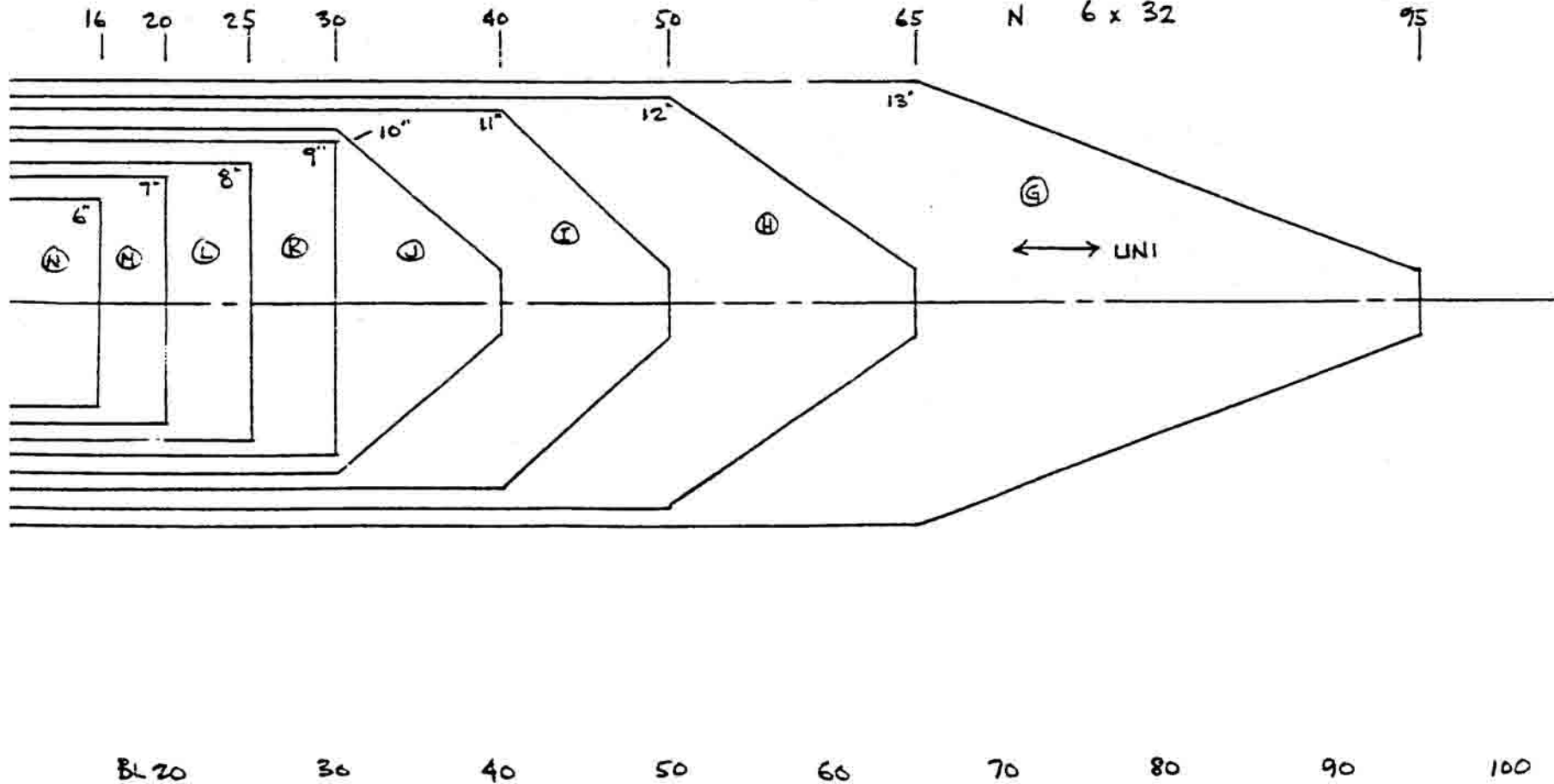

200" CANARD BOTTOM LAYUP SCHEDULE

H. Waddellon
6/86

TRI-Q SPARLESS CANARD

BOTTOM LAYUP SCHEDULE

200" SPAN, 1100 LBS, 4.4 G

LS(1)0417 MOD AIRFOIL

Raw Cloth Dimensions

- A 13" x 180"
- B 12 x 120
- C 11 x 90
- D 10 x 60
- E 9 x 40
- F 8 x 32

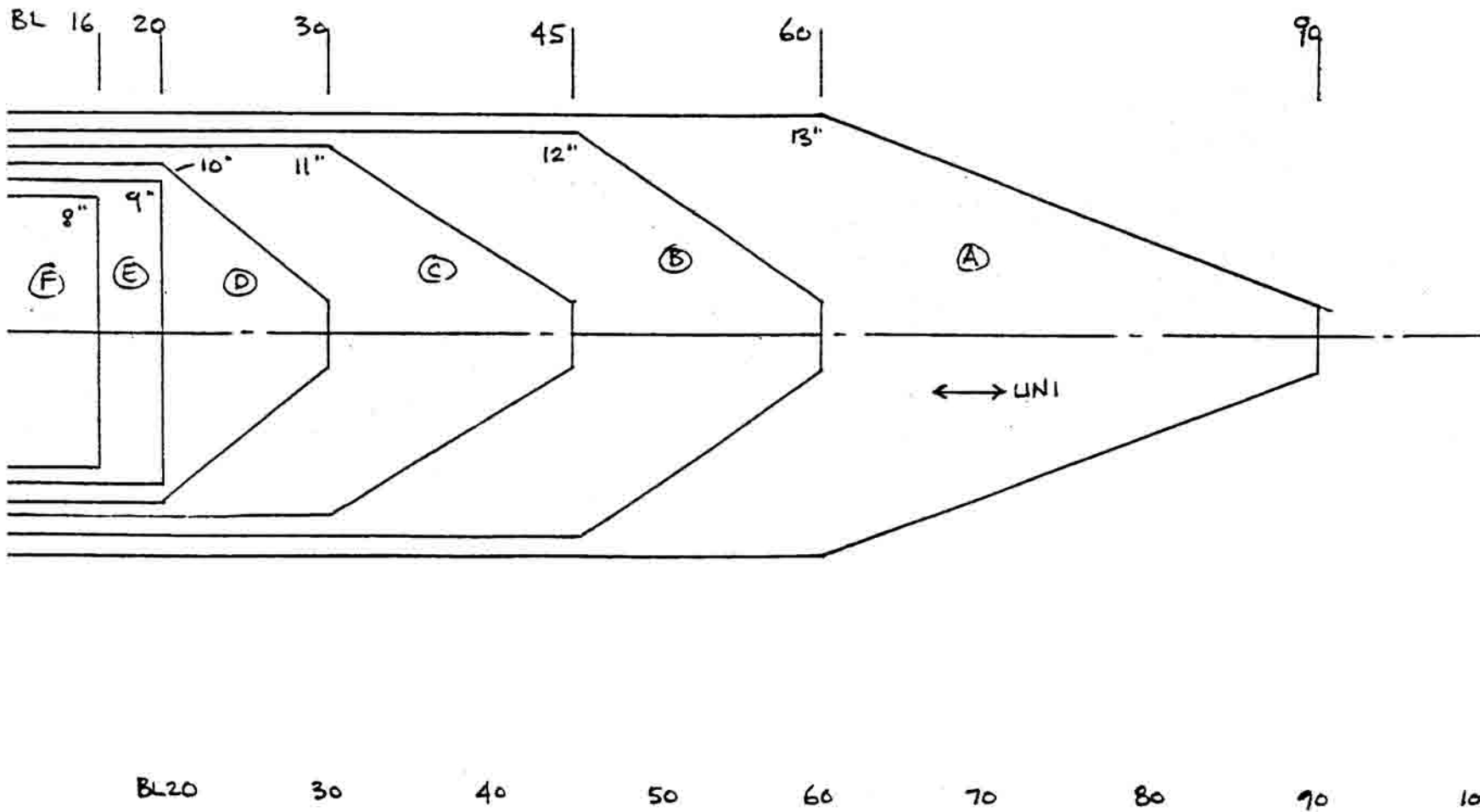

200" MAIN WING TOP LAYUP SCHEDULE

Q2 MAIN WING

TOP SCHEDULE

200" SPAN, 1100 LBS. GROSS

Raw Cloth Dimensions

G	14" x 180"
H	13" x 110"
I	12" x 70"
J	11" x 40"
K	10" x 24"
L	9" x 18"
M	8" x 10"

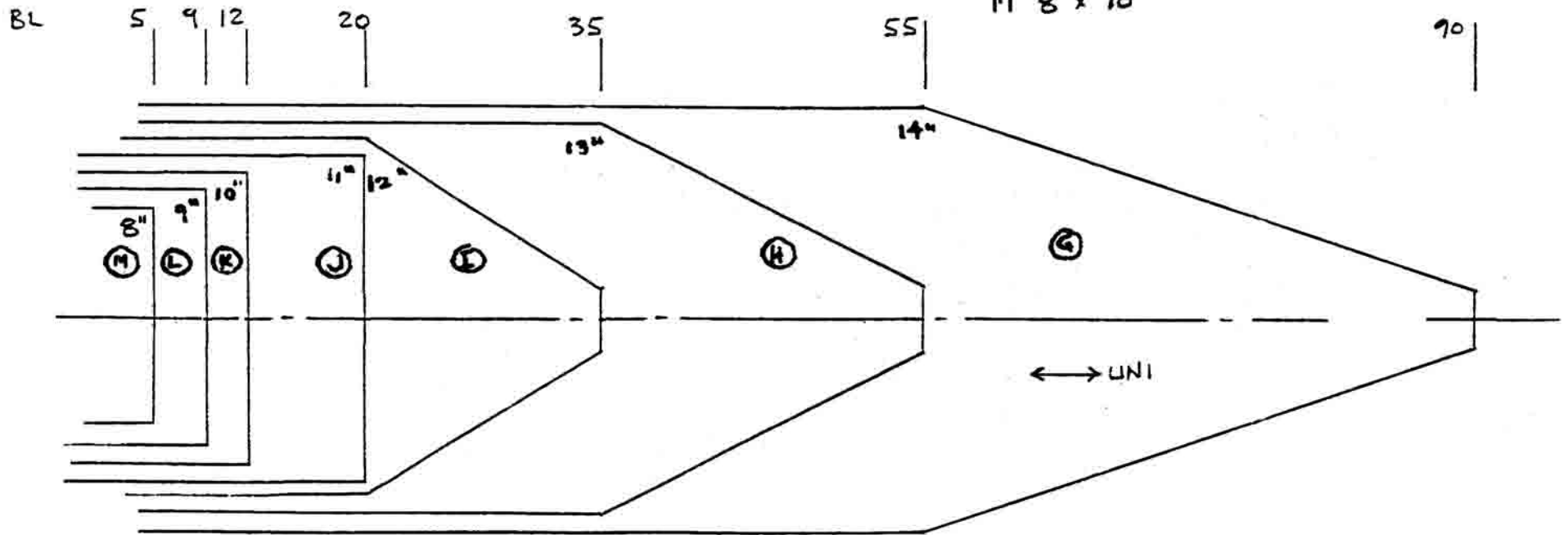

H. Widdellon
6/86

BL 0 10 20 30 40 50 60 70 80 90

200" MAIN WING BOTTOM LAYUP SCHEDULE

H. Waddell
6/86

Q2 MAIN WING

BOTTOM LAYUP SCHEDULE

200" SPAN, 1100 LBS. GROSS

Raw Cloth Dimensions

- A. 10" x 170"
- B. 9" x 110"
- C. 8" x 70"
- D. 7" x 40"
- E. 6" x 26"
- F. 5" x 20"

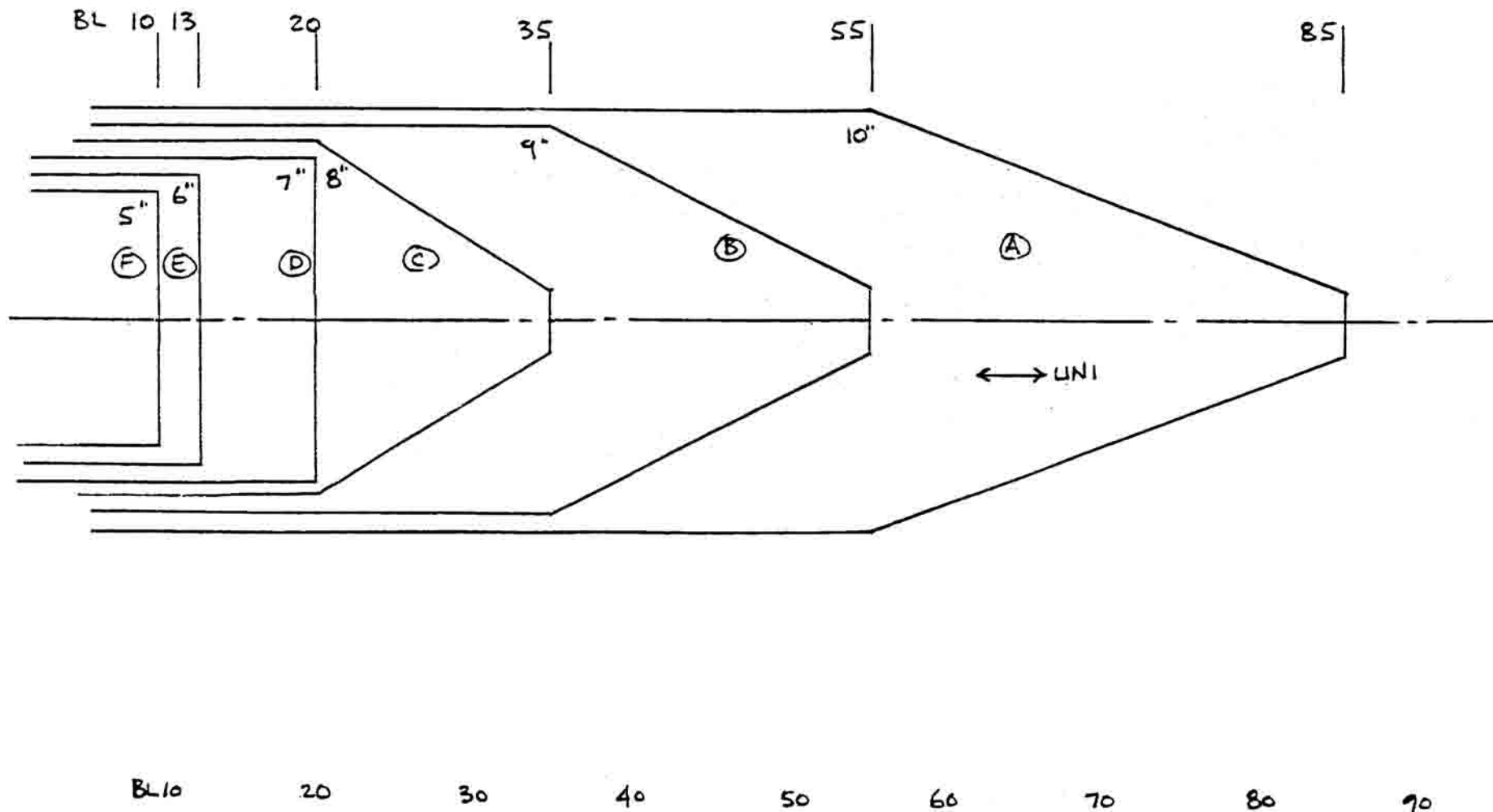

240" CANARD TOP LAYUP SCHEDULE

TOP LAYUP SCHEDULE

246" SPAN. 1200 LBS. GROSS
LSI-0417 MOD, No Carbon Spar

Row Cloth Dimensions:

H	14" x 230"
I	13.5" x 180"
J	13" x 150"
K	12.5" x 120"
L	12" x 100"
M	11.5" x 80"
N	11" x 60"
P	10" x 50"

→ 212 → 218

210

M. M. M.
10/6/85

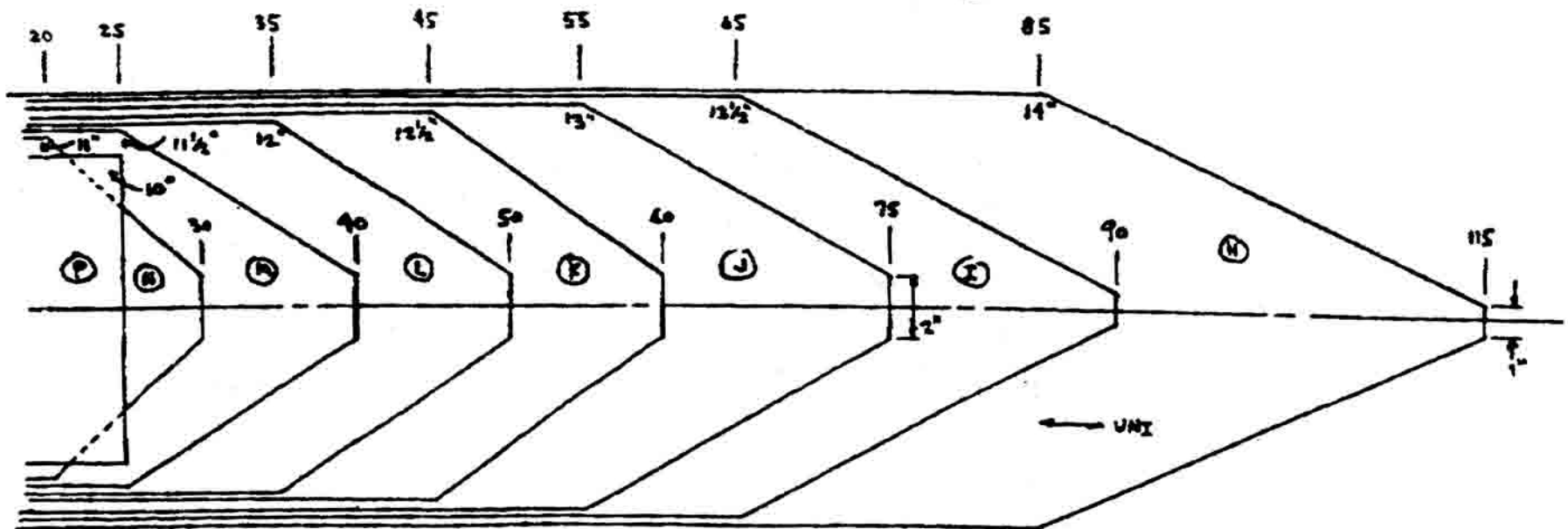

20 25 35 45 55 65 85 30 40 50 60 70 80 90 100 110 120

240" CANARD BOTTOM LAYUP SCHEDULE

BOTTOM LAYUP SCHEDULE

246" Span, 1200 lbs. Gross
 LSI-0417MOD, No Carbon Span

A	14 x 230	⁽²¹⁰⁾ → 212?
B	13 x 160	
C	12 x 130	
D	11 x 100	
E	10 x 80	
F	9 x 60	
G	8 x 40	

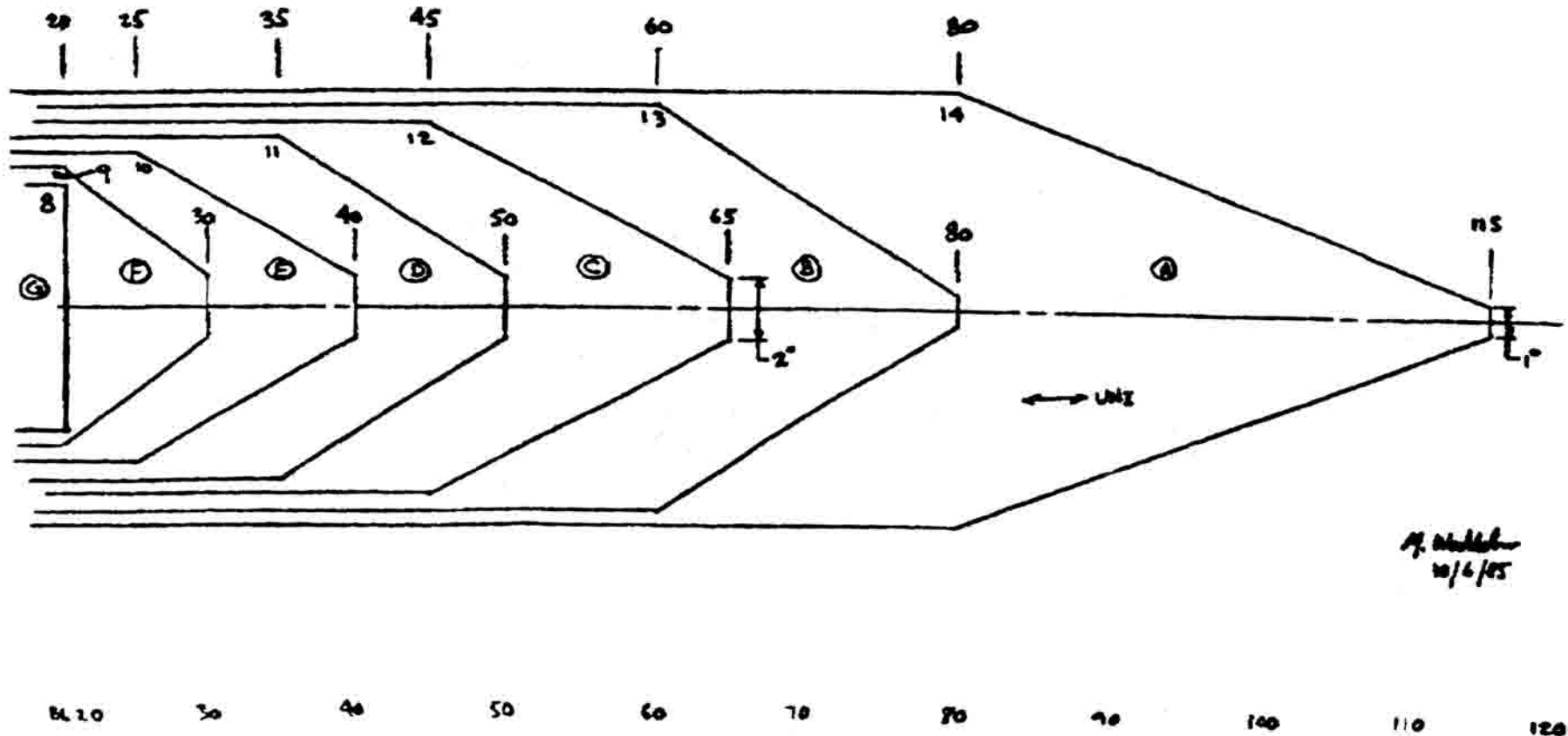

240" MAIN WING TOP LAYUP SCHEDULE

Q2 MAIN WING

TOP LAYUP SCHEDULE

240" SPAN, 1200 LBS. GROSS

Face Cloth Dimensions

G	14 x 210
H	13 x 150
I	12 x 110
J	11 x 80
K	10 x 60
L	9 x 40

H. Y. H. H. H.
8/26/05

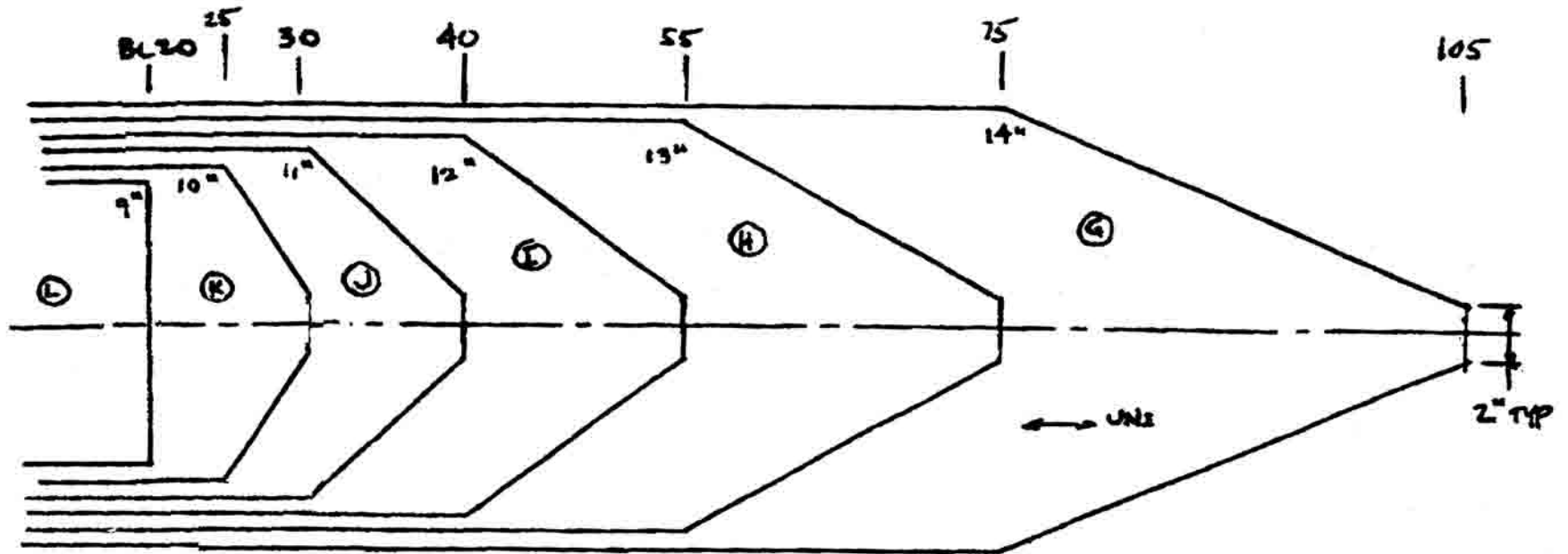

BL20 30 40 50 60 70 80 90 100 110

240" MAIN WING BOTTOM LAYUP SCHEDULE

Q2 MAIN WING

BOTTOM LAYUP SCHEDULE

240" SPAN, 1200 LBS. GROSS

Row Cloth Dimensions

H. Waddell
8/26/85

- A 11" x 200"
- B 10" x 140
- C 9" x 110
- D 8" x 80
- E 7" x 60
- F 6" x 40

